

RS9

VAMPIR



VAMPIR

INSTRUCTION MANUAL

BASIC RULES FOR PISTOL HANDLING

- Always treat your firearm as though it is loaded.
- Always wear hearing protection and protective shooting eyewear when shooting.
- Always use clean, dry, original, high-quality ammunition, which is the appropriate calibre for your firearm.
- Always be certain that the barrel is clean and that the bore and the muzzle are clear of obstructions.
- Always be certain of the target position, what is behind the target and what is in front of and around you and make sure that bystanders are safe when you are shooting.
- Never shoot at hard surfaces and water.
- Keep your firearm inaccessible to children and unauthorised persons and store ammunition locked away in a secure and separate locations.
- Never point your gun at anything you do not intend to shoot.
- Never use drugs, alcohol and other intoxicants when using firearms. Impaired functions can make your firearm handling unsafe.



IMPORTANT!

THE FIREARM HAS BEEN TESTED, INSPECTED AND PACKAGED. THE MANUFACTURER CANNOT CONTROL PRODUCT HANDLING AFTER IT LEAVES THE FACTORY. READ THE INSTRUCTION MANUAL CAREFULLY BEFORE USING THE PRODUCT. INSPECT THE PRODUCT THOROUGHLY PRIOR TO USING IT. THE MANUFACTURER WILL NOT BE HELD LIABLE FOR INJURIES, DEATH OR PERSONAL INJURIES OR PROPERTY DAMAGE RESULTING FROM IMPROPER HANDLING OR USE. FURTHERMORE, THE MANUFACTURER WILL NOT BE HELD LIABLE FOR USE OF THE WRONG CALIBRE OF AMMUNITION, A CORRODED, DAMAGED OR DEFECTIVE BARREL DUE TO PROLONGED PERIODS OF NON-USE.

TABLE OF CONTENTS

01	
INTRODUCTION	10
02	
TECHNICAL CHARACTERISTICS	12
03	
MAIN COMPONENTS	14
04	
STANDARD EQUIPMENT	16

05	
FUNCTIONS	16
06	
DECOCKING LEVER	
(DECOCKER) FUNCTION	18
07	
FIELD STRIPPING	20
08	
CLEANING AND MAINTENANCE	26
09	
WARRANTY CONDITIONS	29

01

INTRODUCTION

The RS9 semi-automatic pistol is designed to meet all the requirements and needs of a military pistol. Safe, reliable and modern, the RS9 follows global trends in the development of military weapons and excels in functionality, speed, precision and durability.



02

TECHNICAL CHARACTERISTICS

MANUFACTURER

TEHNIČKI REMONT BRATUNAC

MODEL

RS9

CALIBRE

9X19 MM PARA

MAGAZINE CAPACITY

18 ROUNDS

DIMENSIONS

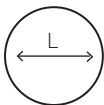

TOTAL LENGTH
190.5 mm

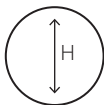

HEIGHT
138.2 mm
(with magazine
150.6 mm)

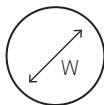

THICKNESS
39.5 mm

BARREL

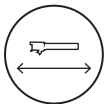

LENGTH
108 mm



TWIST RATE
250 mm

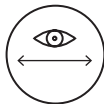

LINE OF SIGHT
161 mm

WEIGHT

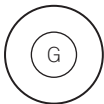

WITHOUT MAGAZINE
820 g



WITH MAGAZINE
920 g



FULLY LOADED
1100 g



03

MAIN COMPONENTS

1. Frame
2. Slide
3. Barrel
4. Front sight
5. Rear sight
6. Trigger
7. Hammer
8. Decocking lever
9. Magazine release
10. Magazine
11. Slide stop

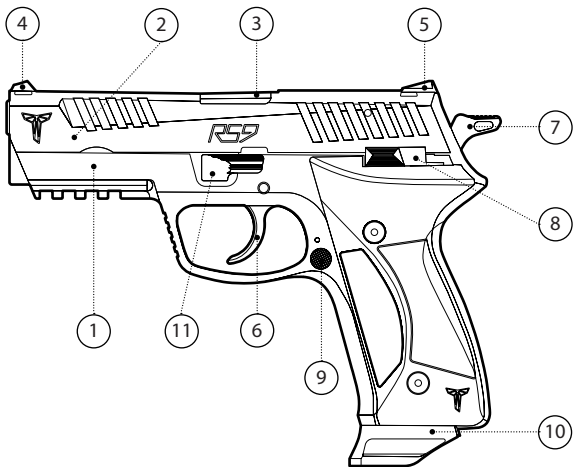

04

STANDARD EQUIPMENT

- Pistol case
- Spare magazine
- Cleaning kit
- Instruction manual

05

PISTOL FUNCTION

To fire, insert the cartridge loaded magazine into the pistol handle with slight force so that it is securely inserted. Pull the slide backwards until the hammer is cocked, then release the slide to the front position to engage the cartridge from the magazine and insert it into the chamber. Pulling the trigger will release the

hammer and deactivate the firing pin block. Under the effect of the spring, the hammer will move forward and strike the firing pin. The firing pin will strike the primer, thus causing firing. When firing, the slide moves backwards and the cartridge case is ejected by the ejector, the slide returns forwards pushing a new cartridge into the chamber and the pistol is ready to be fired again. The cycle will be repeated until the magazine is depleted.

When the magazine is depleted, the slide will remain in its rear or backwards position. To continue shooting, the depleted magazine needs to be replaced. To release the depleted magazine, press the magazine release and insert a new loaded magazine. If it is no longer necessary to use the pistol, press the decocking lever and the slide will return to its original position.

To prevent unintentional firing, which may be caused by accidental dropping or jarring of the pistol, the RS9 is equipped with a firing pin block, which is activated only by pulling the trigger and prevents firing in the above cases.



DECOCKING LEVER (DECOCKER) FUNCTION

The RS9 is a double and single action pistol. Double action refers to the action of pulling on the trigger that cocks and releases the hammer. Single action refers to the action in which pulling the trigger drops the hammer only. In single action pistols, the pistol is cocked either manually or by cycling the slide with each shot. The decocking lever has two functions:

1. When the magazine is depleted and all cartridges are spent, the slide will remain in the rear position. The slide will return to its original position by pressing the decocker.
2. Another important function is when the hammer is cocked and pushed to the firing position. If the user does not want to activate the firing pin and shoot, by pressing the decocking lever, the hammer will return to its original position, hitting the decocker instead of the firing pin and thus preventing firing.

07

FIELD STRIPPING

Ensure and check that the pistol is unloaded.

Proper pistol cleaning requires the pistol to be disassembled into its major components. First, remove the magazine by pressing the magazine release (Figure 1). The magazine can be released by pressing either the left or right side magazine release.

Pull the slide to the rear position, turn the slide stop (Figure 2) and push the slide forward until it is removed from the frame (Figure 3).

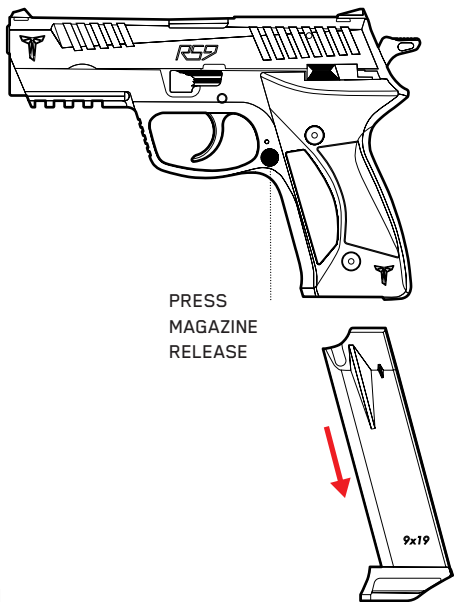

Figure 1

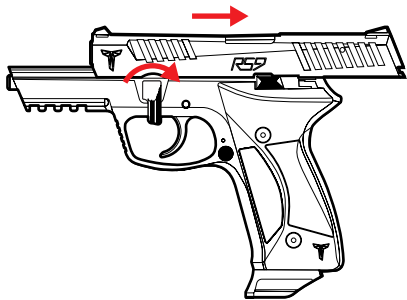

Figure 2

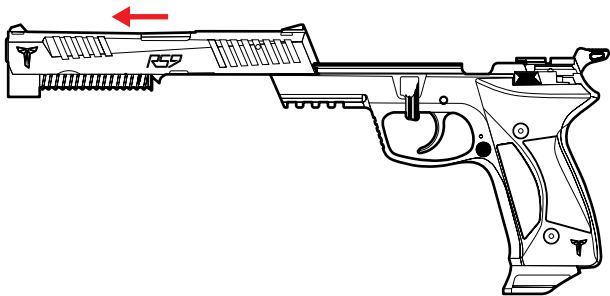
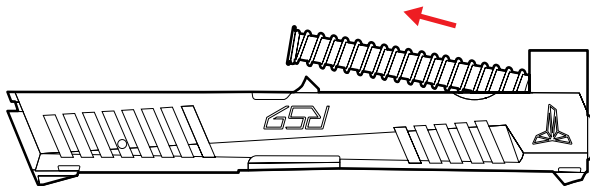

Figure 3

Remove the recoil spring guide from the slide (Figure 4). Separate the barrel from the slide (Figure 5). Clean and maintain the field stripped pistol following the instructions below after each firing or every six months if the pistol is not used. Assemble the pistol in reverse order



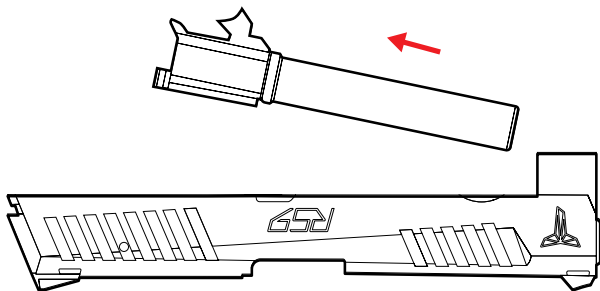

Figure 5

CLEANING AND MAINTENANCE

The cleaning and maintenance kit includes a cleaning rod, bristle brush, felt brush and brass brush. Clean the barrel, slide and grip grooves and lubricate them.

A brass brush is used when the pistol is poorly maintained, when the barrel and other components are partially corroded or fouled up to a great extent. A bristle brush is used for regular cleaning and maintenance, while a felt brush is used for polishing. A cleaning rod is used to clean gunpowder residue with cotton patches.

Although all metal surfaces of the pistol are treated against corrosion, the pistol needs to be lubricated and kept dry and clean. It is necessary to lubricate the surfaces exposed to friction by applying a thin layer as shown in the Figures. Remove the excess oil. Keep the assembled pistol in a dry place.

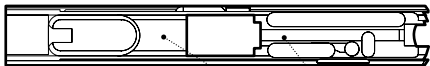

LUBRICATE

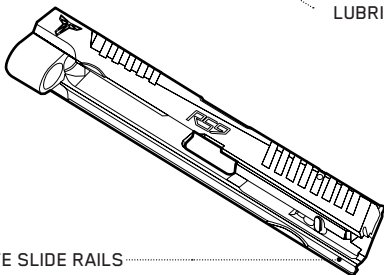

LUBRICATE SLIDE RAILS

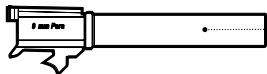

LUBRICATE

LUBRICATE SLIDE RAILS

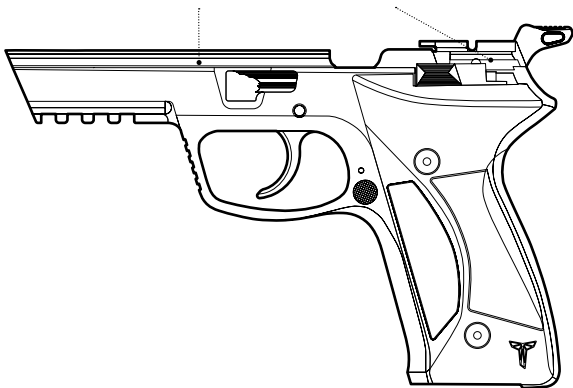

WARRANTY CONDITIONS

1. The warranty conditions shall be void if the weapon is disassembled beyond the provided instructions for disassembly of the main components, if it is damaged, modified or improperly assembled. Should any of the above stated action result in a property damage, injury or death, the manufacturer will assume no liability.
2. The warranty conditions will not apply if the ammunition used is in poor condition, handloaded, inadequate for the given weapon or fails to meet standards.
3. In the case of unlawful use of the weapon, the manufacturer will assume no liability for any property damage, injury or death.

SERVICING AND MAINTENANCE:

Ref. no.	Date	Note

